

11. PROGRAMMABLE CONTROL TIMERS

PURPOSE

Programmable control timers are used to control the work time of devices included into industrial or household automatic systems in compliance with individual time schedule planned by the user.

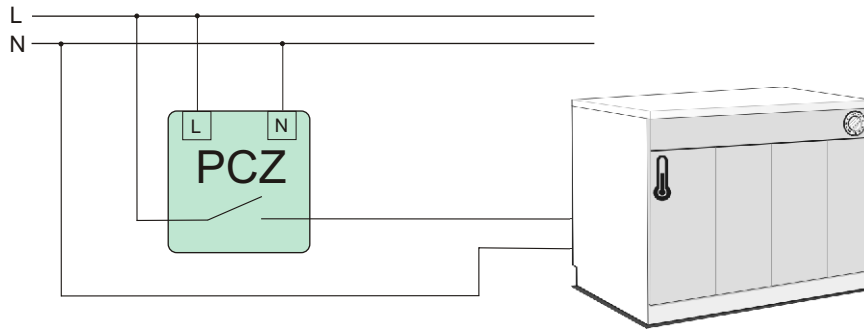

ATTENTION!

Daylight Saving Time - automatic change function! (Concerns all types)

Time change from winter to summer occurs automatically at 2 a.m. On the last sunday of March by adding one hour to the current time.

Time change from summer to winter occurs automatically at 3 a.m. on the last sunday of October by taking away one hour from the current time.

ATTENTION! It is possibilities to switch-OFF of automatic change function.

WEEKLY CYCLES TYPE

FUNCTIONING

The timer activates and deactivates a given device at preset hours in the following cycles: 24-hour, weekly, working day (Mon-Fri) or weekend (Sat, Sun).

PCZ-521

One-way type. 250 of program memory sectors.

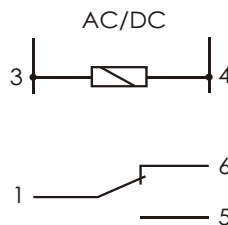

supply	24+264V AC/DC
current load	<16A
contacts	1C/O
display maintenance time	non
timer maintenance time	6 years
indication accuracy item	1sec
time deviation	±1sec/24h
schedule time accuracy item	1min
no. of program memory sectors	250
	(125 entry pairs: ON/OFF)
power consumption	1,5W
working temperature	-25+50°C
connection	screw terminals 2,5mm ²
dimensions	2 modules (35mm)
fixing	on rail TH-35

PCZ-522

Two-way type. 2×250 of program memory sectors.

With two independent separately programmable ways.

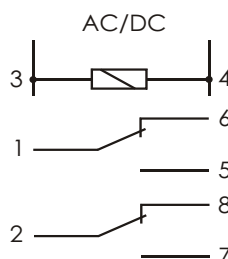

supply	24+264V AC/DC
current load	2×(<16A)
contacts	2×1C/O
display maintenance time	non
timer maintenance time	6 years
indication accuracy item	1sec
time deviation	±1sec/24h
schedule time accuracy item	1min
no. of program memory sectors	2×250
	(2×125 entry pairs: ON/OFF)
power consumption	1,5W
working temperature	-25+50°C
connection	screw terminals 2,5mm ²
dimensions	2 modules (35mm)
fixing	on rail TH-35

PULSE-TYPE

PCZ-523

One-way type with two programme lines.

FUNCTIONING

The PCZ-523 activates a given device at a preset time and deactivates it after preset time (by pulse) in the following cycles: 24-hour, weekly, working day (Mon-Fri) or weekend (Sat, Sun). Pulse range: 1 sec. + 99 min. 59 sec. The relay has been equipped with two independent switch able programme lines to control an connected receiver.

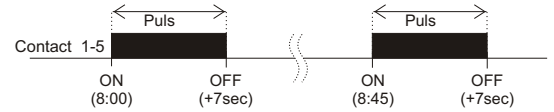
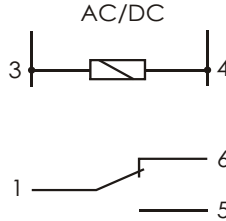

supply	24+264V AC/DC
current load	<16A
contacts	1C/O
display maintenance time	non
timer maintenance time	6 years
indication accuracy item	1sec
time deviation	±1sec/24h
time accuracy item	1s+99min59sec
schedule time accuracy item (pulse)	1sec
no. of program memory sectors	2x(125/per programme line)
power consumption	1,5W
working temperature	-25+50°C
connection	screw terminals 2,5mm ²
dimensions	2 modules (35mm)
fixing	on rail TH-35

ANNUAL TYPE

PCZ-529 One-way type

FUNCTIONING

Time control of devices in domestic or industrial automatic-control device systems according to internal time management program preset by the user. It allows a selection of the superordinate device responsible for seasonal cycles of an automatically controlled system. The timer activates and deactivates a given device to prescheduled dates in the annual cycle. Activation sequence available for a single, selected day of the year.

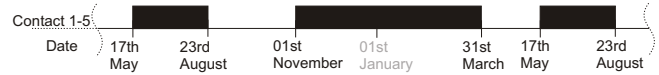
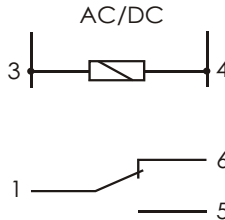

supply	24+264V AC/DC
current load	<16A
contacts	1C/O
display maintenance time	1+2h
timer maintenance time	5+6 weeks
schedule maintenance time	10 years
battery recharge time	30h
Indication accuracy item	1sec
time deviation	±1s/24h
schedule time accuracy item	24h
no. of program memory sectors	198storage cells (99 entry pairs: ON/OFF)
power consumption	1,5W
working temperature	-20+50°C
connection	screw terminals 2,5mm ²
dimensions	2 modules (35mm)
fixing	on rail TH-35

Easily programmable! Menu diagram and operational sequence for timer programming.

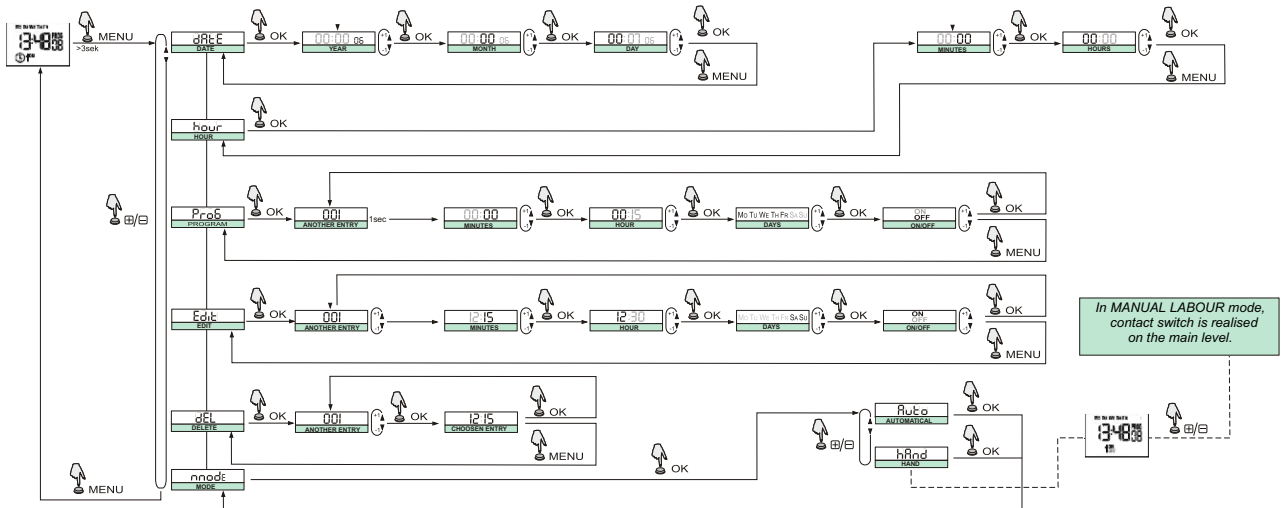

ASTRONOMICAL TYPE

FUNCTIONING

The astronomical timer activates and deactivates a device at certain hour, i.e. at sunrise and sunset. Should more settings that are precise be required for locations of different geographical co-ordinates, there is an option to set a given longitude and latitude or select a special code which entails automatic setting of these co-ordinates for a given place in Europe (list of locations and their codes may be found in the manual). Furthermore, there is an option to shift the preset activation/deactivation time for ± 99 min. for sunrise and sunset times separately.

Code	City	°N	°E	City	Country
1	Praga	50 08	14 25	Prague	CZECHY
2	Plizno	49 47	13 22	Plzen	
3	Budejovice	48 58	14 29	Ceske Budejovice	
4	Brno	49 10	16 37	Brno	
5	Olomouc	49 35	17 15	Olomouc	
6	Ostrava	49 51	18 19	Ostrava	
7	Hradec Kralove	50 13	15 49	Hradec Kralove	
8	Bratislava	48 08	17 05	Bratislava	SLOVACIA
9	Zylina	49 13	18 44	Zilina	
10	Banska Bystrica	48 44	19 08	Banska Bystrica	
11	Poprad	49 03	20 17	Poprad	
12	Koszyce	48 43	21 15	Kosice	WĘGRY
13	Budapeszt	47 30	19 04	Budapest	
14	Debrecen	47 33	21 37	Debrecen	
15	Szeged	46 15	20 08	Szeged	
16	Szombathely	47 13	16 37	Szombathely	
17	Gyor	47 40	17 38	Gyor	
18	Wilno	54 42	25 17	Vilnius	LITWA
19	Kowno	54 54	23 53	Kaunas	
20	Klajpeda	55 41	21 08	Klaipeda	
21	Poniewież	55 43	24 21	Panevezys	
22	Szawie	55 56	23 18	Siauliai	

...

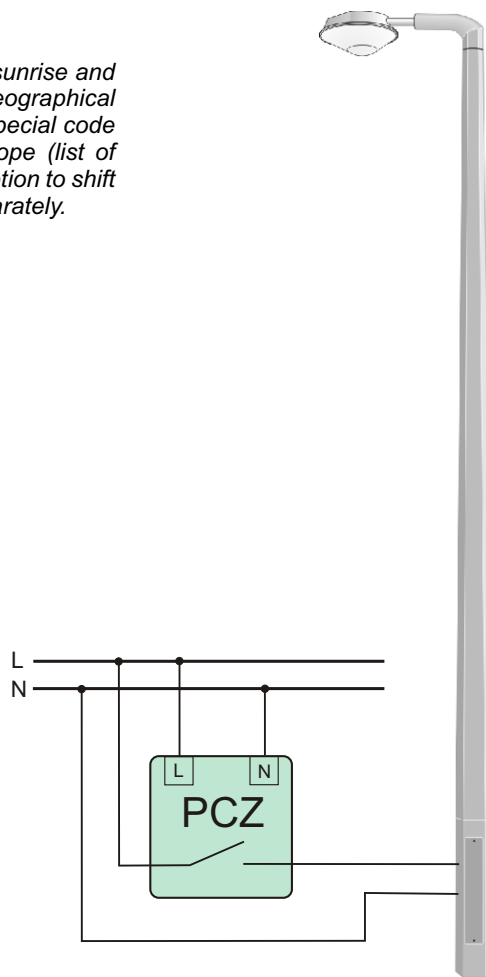

ATTENTION!

Daylight Saving Time - automatic change function! (Concerns all types)

Time change from winter to summer occurs automatically at 2 a.m. On the last sunday of March by adding one hour to the current time.

Time change from summer to winter occurs automatically at 3 a.m. on the last sunday of October by taking away one hour from the current time.

ATTENTION! It is possibilities to switch-OFF of automatic change function.

PCZ-524

One-way type.

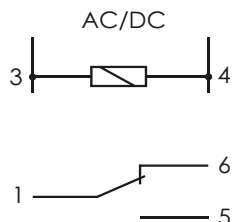

supply	24+264V AC/DC
current load	<16A
contacts	1C/O
display maintenance time	non
timer maintenance time	6 years
indication accuracy item	1sec
time deviation	$\pm 1\text{sec}/24\text{h}$
schedule time accuracy item	1min
activation/deactivation time correction	$\pm 0+99\text{min}$
schedule correction accuracy item	1min
power consumption	1,5W
working temperature	$-25+50^\circ\text{C}$
connection	screw terminals 2,5mm ²
dimensions	2 modules (35mm)
fixing	on rail TH-35

with programmeable night interval (PCZ-525.2, PCZ-526.2)

FUNCTIONING

Like PCZ-524.2. Another feature enables the user to set the so-called night interval between the pre-programmed actuation times, i.e. turning off the controlled receiver for a given period t (e.g. from 11 p.m. (t_1) to 04.00 a.m. (t_2)).

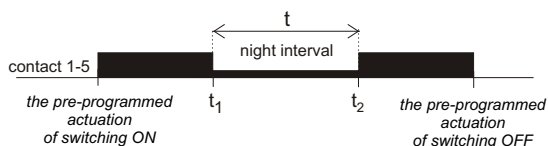

PCZ-525 One-way type.

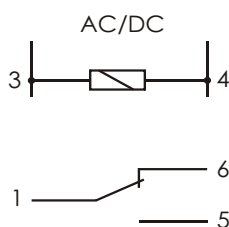

supply	24+264V AC/DC
current load	<16A
contacts	1C/O
display maintenance time	non
timer maintenance time	6 years
schedule maintenance time	1 sec
battery recharge time	±1sec/24h
indication accuracy item	1min
time deviation	±0+99min
schedule time accuracy item	1min
activation/deactivation time correction	00:00+24:00
schedule correction accuracy item	1,5W
interval time setting range	-25+50°C
power consumption	screw terminals 2,5mm ²
working temperature	2 modules (35mm)
connection	on rail TH-35
dimensions	
fixing	

PCZ-526 Two-way type

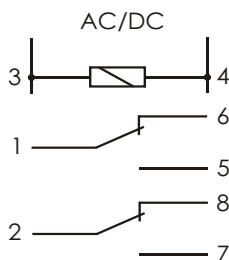

supply	24+264V AC/DC
current load	<16A
contacts	2x1C/O
display maintenance time	non
timer maintenance time	6 years
indication accuracy item	1sec
time deviation	±1sec/24h
schedule time accuracy item	1min
activation/deactivation time correction	±0+99min
schedule correction accuracy item	1min
interval time setting range	00:00+24:00
power consumption	1,5W
working temperature	-25+50°C
connection	screw terminals 2,5mm ²
dimensions	2 modules (35mm)
fixing	on rail TH-35